

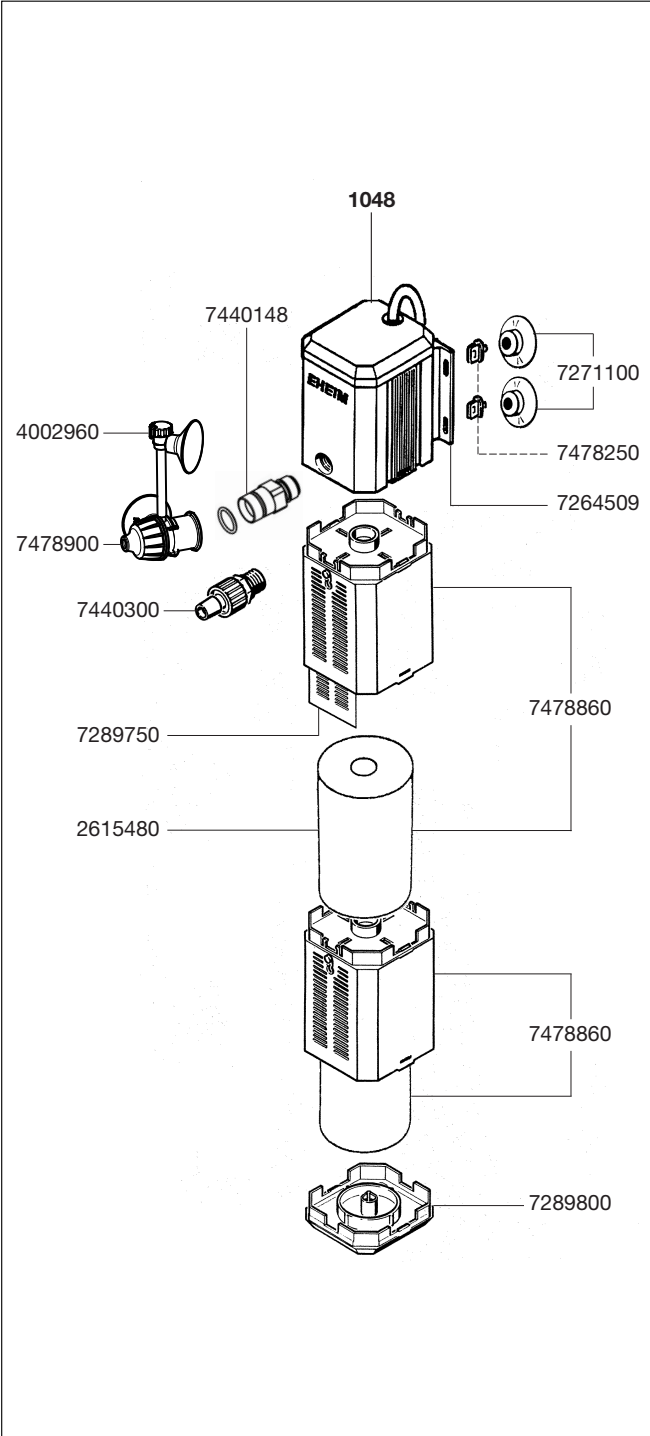

2048

Innenfilter	D
Internal filter	GB / USA
Filtre intérieur	F
Binnenfilter	NL
Innerfilter	S
Innvendig filter	N
Sisäsuodatin	FIN
Indvendig filter	DK
Filtro interno	I
Filtro interior	E

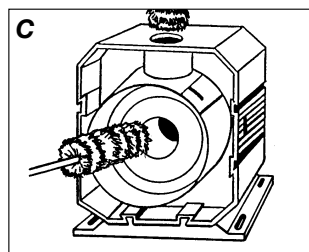

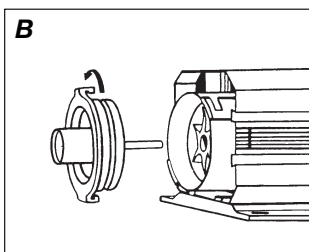
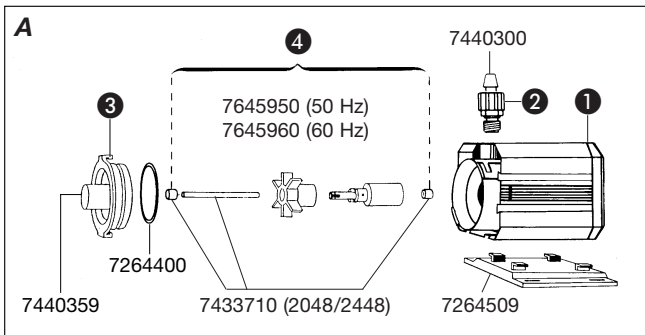
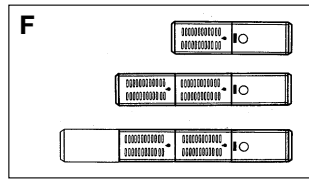
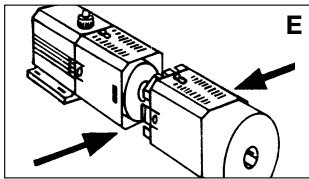
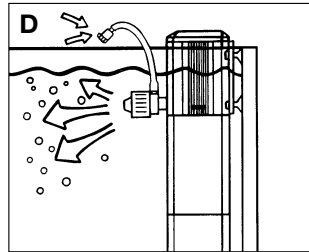
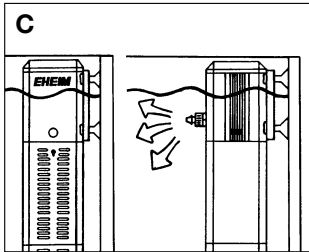
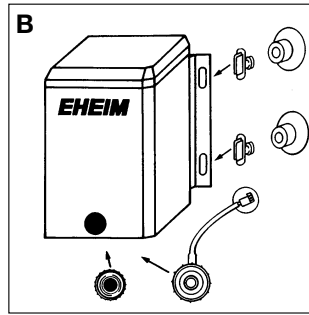
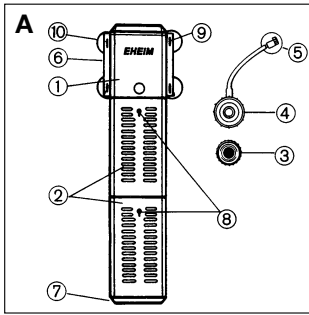

Sicherheitshinweise

Nur in geschlossenen Räumen für aquaristische Einsatzbereiche verwenden.



Bevor man mit der Hand ins Aquarienwasser eintaucht, alle im Wasser befindlichen Elektrogeräte vom Netz trennen. Vor dem Öffnen des Filters, diesen generell vom Stromnetz trennen.



Die Anschlussleitung des Gerätes kann nicht ersetzt werden. Bei Beschädigung des Kabels darf das Gerät nicht mehr benützt werden. Wenden Sie sich an Ihren Fachhändler oder an Ihre EHEIM Service-Stelle.



Dieses Gerät ist nicht dafür bestimmt, durch Personen (einschließlich Kinder) mit eingeschränkten physischen, sensorischen oder geistigen Fähigkeiten oder mangels Erfahrung und/oder mangels Wissen benutzt zu werden, es sei denn, sie werden durch eine für Sicherheit zuständige Person beaufsichtigt oder erhalten von ihr Anweisungen, wie das Gerät zu benutzen ist. Kinder sollten beaufsichtigt werden, um sicherzustellen, dass sie nicht mit dem Gerät spielen.



Bei diesen Geräten können Magnetfelder elektronische oder mechanische Störungen oder Beschädigungen hervorrufen. Dies gilt auch für Herzschrittmacher. Die erforderlichen Sicherheitsabstände sind den Handbüchern dieser medizinischen Geräte zu entnehmen.



Achtung: Bei Wartungsarbeiten besteht Quetschgefahr für die Finger durch hohe Magnetkräfte.



Zu Ihrer eigenen Sicherheit empfiehlt es sich, mit dem Netzkabel eine Tropfschleife zu bilden, die verhindert, dass evtl. am Kabel entlang laufendes Wasser in die Steckdose gelangt. Bei Verwendung einer Verteiler-Steckdose muss die Platzierung oberhalb des FilterNetzanschlusses erfolgen.

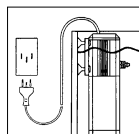

Vorsichtsmaßnahmen bei Handhabung elektrostatisch entladungsgefährdeter Bauelemente beachten.



Gerät – oder Teile davon – nicht in der Spülmaschine reinigen. Nicht spülmaschinenbeständig!



Dieses Produkt nicht mit dem normalen Hausmüll entsorgen. Führen Sie es Ihrer örtlichen Entsorgungsstelle zu.

Das Produkt ist nach den jeweiligen nationalen Vorschriften und Richtlinien approbiert und entspricht den EU-Normen.

**Innenfilter 2048**

Ausführung: siehe Typenschild am Pumpengehäuse

Funktion

- A** ① Pumpe ② Filterbehälter mit Patrone ③ Auslaufstutzen ④ Diffusor ⑤ Luftregulierventil ⑥ Befestigungsplatte ⑦ Filterboden ⑧ Verschluss-Schieber ⑨ Klemmstopfen ⑩ Sauger.

Installation

- B** Klemmstopfen in die Öffnungen der Pumpen-Befestigungsplatte einclippen; Sauger aufstecken. Die Befestigungsplatte lässt sich auch wahlweise an den Seitenwänden der Pumpe einschieben, wodurch eine Filtermontage nach allen Richtungen möglich ist.

- C/D** Wahlweise Auslaufstutzen **(C)** oder Diffusor **(D)** einschrauben.

Auslaufstutzen: Für gute Oberflächenbewegung.

Diffusor: Bevorzugt für Seewasser- und unbepflanzte Süßwasseraquarien. Mit dem Luftreguliertventil am Luftschlauch des Diffusors kann die Sauerstoffmenge gedrosselt werden.

Verschluss-Schieber öffnen, Filter im Aquarium befestigen (Mindest-Eintauchtiefe siehe Bild **C**) und über Netzstecker in Betrieb nehmen.

Inbetriebnahme

- E** Durch eindrücken der seitlichen Arretierungspunkte lassen sich die Module leicht abnehmen.

Um den biologischen Filterprozess nicht zu unterbrechen, empfiehlt sich das wechselweise Auswaschen oder Ersetzen der Patronen (Best.-Nr. 2615480). Dies ist dann erforderlich, wenn die Pumpenleistung merklich nachlässt. **ACHTUNG:** Den Verschluss-Schieber vor dem Herausnehmen des Filters schließen.

- F** Durch verringern oder erweitern der Module kann die Filterfläche individuell verändert werden (Zubehör: Behälterteil mit Filterpatrone Best.-Nr. 7478860).

Kreiselpumpe 1048

- A** ① Motorkörper ② Gewindestutzen ③ Haltering ④ Pumpenteile

Pflege und Wartung

B/C Netzstecker ziehen. Haltering entriegeln (**B**). Pumpenteile (s. Zeichnung **A**) herausnehmen. Pumpe (**C**) mit Reinigungsbürsten-Set (Best.-Nr. 4009550) kräftig säubern; Pumpenteile unter fließendem Wasser reinigen und anschließend in gleicher Reihenfolge wieder zusammensetzen.

ACHTUNG: Die Pumpe darf nicht trocken laufen.

INSTRUCTIONS FILTER 2048, PUMP 1048

IMPORTANT SAFETY INSTRUCTIONS

WARNING – To guard against injury, basic safety precautions should be observed, including the following.

- a) **READ AND FOLLOW ALL SAFETY INSTRUCTIONS.**
- b) **DANGER** – To avoid possible electric shock, special care should be taken since water is employed in the use of aquarium equipment. For each of the following situations, do not attempt repairs by yourself; return the appliance to an authorized service facility for service or discard the appliance.
- 1) If the appliance falls into the water, **DON'T** reach for it! First unplug it and then retrieve it. If electrical components of the appliance get wet, unplug the appliance immediately. (Non-immersible equipment only)
 - 2) If the appliance shows any sign of abnormal water leakage, immedi-

ately unplug it from the power source. (Immersible equipment only).

3) Carefully examine the appliance after installation. It should not be plugged in if there is water on parts not intended to be wet.

4) Do not operate any appliance if it has a damaged cord or plug, or if it is malfunctioning or has been dropped or damaged in any manner.

5) To avoid the possibility of the appliance plug or receptacle getting wet, position aquarium stand and tank to one side of a wall-mounted receptacle to prevent water from dripping onto the receptacle or plug.

A "drip-loop", shown in the figure below, should be arranged by the user for each cord connecting an aquarium appliance to a receptacle. The "drip-loop" is that part of the cord below the level of the receptacle, or the connector if an extension cord is used, to prevent water traveling along the cord and coming in contact with the receptacle.

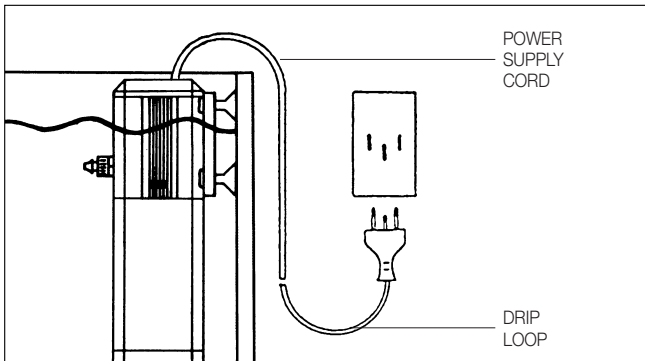

If the plug or socket does get wet, **DON'T** unplug the cord. Disconnect the fuse or circuit breaker that supplies power to the appliance. Then unplug and examine for presence of water in the receptacle.

- c) Close supervision is necessary when any appliance is used by or near children.
- d) To avoid injury, do not contact moving parts or hot parts such as heaters, reflectors, lamp bulbs, and the like.
- e) Always unplug an appliance from an outlet when not in use, before putting on or taking off parts, and before cleaning. Never yank cord to pull plug from outlet. Grasp the plug and pull to disconnect.
- f) Do not use an appliance for other than intended use. The use of attachments not recommended or sold by the appliance manufacturer may cause an unsafe condition.
- g) Do not install or store the appliances where it will be exposed to the weather or to temperatures below freezing.
- h) Make sure an appliance mounted on a tank is securely installed before operating it.
- i) Read and observe all the important notices on the appliance.
- j) If an extension cord is necessary, a cord with a proper rating should be used. A cord rated for less amperes or watts than the appliance rating may overheat. Care should be taken to arrange the cord so that it will not be tripped over or pulled.

- k) This appliance has a polarized plug (one blade is wider than the other). As a safety feature, this plug will fit in a polarized outlet only one way. If the plug does not fit fully in the outlet, reverse the plug. If it still does not fit, contact a qualified electrician. Never use with an extension cord unless plug can be fully inserted. Do not attempt to defeat this safety feature.

Exception: This instruction may be omitted for an appliance that is not provided with a polarized attachment plug.

l) "SAVE THESE INSTRUCTIONS".

GROUNDING INSTRUCTIONS

This appliance should be grounded to minimize the possibility of electric shock. This appliance is equipped with an electric cord having an equipment grounding conductor and a grounding-type plug. The plug must be plugged into an outlet that is properly installed and grounded in accordance with all appropriate codes and ordinances.

This appliance is for use on a nominal 120 V circuit, and has a grounding plug that looks like the plug illustrated in Sketch **A**. A temporary adapter which looks like the adapter illustrated in Sketches **B** and **C**, may be used to connect this plug to a two pole receptacle as shown in Sketch **B** if a properly grounded outlet is not available. The temporary adapter should be used only until a properly grounded outlet can be installed by a qualified electrician. The green colored rigid ear (lug, etc.) extending from the adapter must be fastened to a permanent ground such as a properly grounded outlet box.

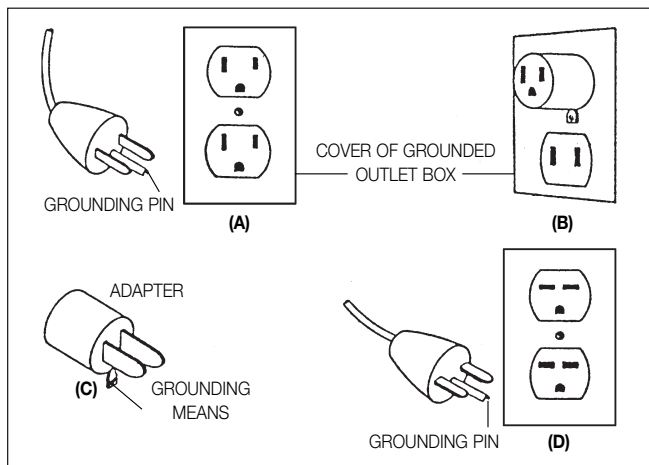

English

EHEIM

Safety instructions



For indoor use only. For use with aquariums.



All electrical equipment in the water must be disconnected from the mains during care and maintenance work.

It is imperative to disconnect the filter from the mains prior to opening it.



The connecting line of this device can not be replaced. When the line is damaged, the device must no longer be used. Contact your specialised dealer or your EHEIM Service Centre.



This equipment is not intended for use by persons (including children) with limited physical, sensory or mental abilities or for persons with no experience or knowledge unless they are supervised by a person responsible for safety or unless they have received from such a person instructions on how to use the equipment. Children should be supervised to ensure that they do not play with the equipment.



20 cm



Notice: These devices produce magnetic fields which might cause electronic and mechanical disturbances or damages. This also refers to pacemakers. Please consult the manuals of medical equipment for the required safety margins.



Attention: Maintenance work presents the risk of crushing the fingers due to high magnetic forces.



For your own safety, we recommend to form a drip loop with the connection cable to prevent any water running along the cable from intruding into the socket. When using a multiple socket or an external power supply unit, position them atop the filter's power connection.

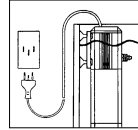

Take the necessary precautions when handling components that can discharge static electricity.



Do not clean the unit – or parts of it – in the dishwasher. Not dishwasher resistant!



Do not dispose of this product as normal household waste. Take it to your local refuse collection side.

The product is qualified in accordance with the respective national regulations and guidelines and meets EC standards.



Internal filter 2048

Model: see type plate on pump housing

Function

- A** ① Pump ② Filter module with cartridge ③ Discharge connection ④ Diffusor ⑤ Air regulating valve ⑥ Retaining plate ⑦ Filter bottom ⑧ Closing slide ⑨ Clamping plug ⑩ Suction cup.

Installation

- B** Clip clamping plug into apertures in retaining plate. Install suction pads. If preferred, the retaining plate can be attached to one side of the pump, permitting the filter to be installed facing in any direction.

- C/D** Screw in either discharge connection (**C**) or diffusor (**D**) as required.

Discharge connection: used for good water surface movement. Height of filter is regulated by means of perforated locking device on mounting support. Diffusor: This is preferable for aquariums without plants. The oxygen supply can be regulated by the air regulating valve.

Open filter shutter and secure filter in aquarium (for minimum immersion depth, see diagram **C**). Connect electrical plug to initiate filter operation.

Putting into operation

- E** Modules can be easily separated by the application of light pressure on the locking points at the sides.
- The cartridges (order no. 2615480) should be washed out and replaced alternately to prevent the biological filtering process from being interrupted. This is necessary when the pump performance becomes noticeably reduced. **CAUTION:** Make sure you close the filter shutter before removing the filter.
- F** The filtering area can be changed individually by reducing or extending the modules. (Accessory item – order no. 7478860, filter module with filter cartridge.)

Universal centrifugal pump 1048

- A** ① Motor ② Threaded adaptor ③ Clamping ring ④ Pump parts

Servicing and maintenance

- B/C** Remove power supply plug. Release clamping ring (**B**) and remove pump parts as per drawing (**A**). Clean pump thoroughly with EHEIM brush set (order no. 4009550) (**C**). Clean pump under running water, then reassemble in correct sequence.

CAUTION: The pump has not to run dry.

Français

EHEIM

Consignes de sécurité



Usage intérieur exclusivement. Destiné à être utilisé uniquement en aquariophilie.



Avant de plonger la main dans l'eau de l'aquarium, retirer les prises électriques de tous les appareils installés dans l'eau. Avant d'ouvrir le filtre, le débrancher entièrement du secteur.



La ligne de raccordement de l'appareil ne peut pas être remplacée. L'usage de l'appareil est interdit lorsque le câble est endommagé ou coupé. Adressez-vous à votre négociant spécialisé ou à votre service après-vente EHEIM.



Cet appareil n'est pas destiné à être utilisé par des personnes (enfants y compris) aux capacités physiques, sensorielles ou intellectuelles limitées ou dépourvues d'expérience ou de connaissance, à moins qu'elles ne se trouvent sous la surveillance d'une personne responsable de la sécurité et obéissent à ses recommandations sur la manière d'utiliser l'appareil. Veuillez surveiller les enfants afin de pouvoir être certain qu'ils ne jouent pas avec l'appareil.



20 cm | Remarque: avec ces appareils, des champs magnétiques peuvent provoquer des troubles ou des détériorations électroniques et mécaniques. Ceci est également valable pour les stimulateurs cardiaques. Les distances nécessaires de sécurité doivent être relevées dans les manuels de ces appareils médicaux.



Attention: en cas de travaux de maintenance, risque de coincement en raison de forces magnétiques élevées.



Pour votre propre sécurité, nous vous recommandons de former un col de cygne avec le câble pour éviter que l'eau s'écoulant éventuellement de

long du câble ne pénètre dans la prise. En utilisant par exemple une multiprise, celle-ci doit être placée plus haut que la prise de secteur du filtre.

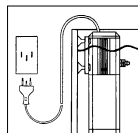

Respecter les indications de sûreté en manipulant des éléments de construction qui risquent des décharges électrostatiques.



Ne nettoyez pas cet appareil – ou les pièces qui le composent – au lave-vaisselle. Ne résiste pas au lave-vaisselle.



Ne pas jeter le présent produit à la poubelle. Ramenez-le à votre lieu de décharge locale.

Le produit est autorisé à l'emploi conformément aux réglementations et directives nationales respectivement en vigueur. Il respecte les normes adoptées par l'Union européenne.



Filter intérieur 2048

Version: voir indication de type sur le corps de la pompe

Fonction

- A** ① Pompe ② Bacs à filtre avec cartouche ③ Tubulure d'écoulement ④ Diffuseur ⑤ Pince régulatrice d'air ⑥ Plaque de fixation ⑦ Fond du filtre ⑧ Coulisse de fermeture ⑨ Bouchons de serrage ⑩ Crépine.

Installation

- B** Clipser les bouchons de serrage dans les ouvertures de réglettes de fixation de la pompe et y monter les ventouses. Les réglettes de fixation peuvent également être glissées sur les parois latérales de la pompe, ce qui permet de monter le filtre dans n'importe quel sens.
- C/D** Visser au choix la tubulure d'écoulement (**C**) ou le diffuseur (**D**).
Tubulure d'écoulement: pour un bon mouvement de surface. Diffuseur: Idéal pour les aquariums contenant de l'eau salée ou de l'eau douce sans végétation aquatique. A l'aide de la pince régulatrice d'air se trouvant sur le tuyau d'air du diffuseur on peut réduire la quantité d'oxygène.
- Ouvrir les coulisses de fermeture, fixer le filtre dans l'aquarium (immersion minimale voir fig. **C**) et mettre en service en enfichant la prise.

Mise en service

- E** Les modules se séparent aisément, par simple pression sur les crans d'arrêt latéraux. Afin de ne pas interrompre le processus de filtrage biologique il est recommandé de laver ou de remplacer alternativement les cartouches (no. de réf. 2615480). Cette mesure s'impose lorsque le débit de la pompe s'affaiblit. **ATTENTION:** Fermer les coulisses de fermeture avant de retirer le filtre.
- F** En réduisant ou en augmentant les modules, on peut modifier individuellement la surface du filtre (accessoires: pièce de bac avec cartouche filtrante: no. de réf. 7478860).

Pompe rotative 1048

- A** ① Corps du moteur ② Embouts filetés ③ Bague de fermeture ④ Éléments de pompe

Nettoyage et entretien

B/C Retirer la prise du réseau. Déverrouiller la bague de fermeture (**B**) et retirer les éléments de pompe (**A**) comme indiqué sur l'illustration. Nettoyer soigneusement la pompe (voir illustration **C**) à l'aide du jeu de brosses EHEIM (no. de réf. 4009550). Laver les éléments à l'eau courante pour les remonter dans le sens inverse du démontage.

ATTENTION: La pompe ne doit jamais tourner à sec.

Nederlands

EHEIM

Veiligheidsinstructies



Alleen binnenshuis te gebruiken. Voor aquaristische doeleinden.



Voordat U met Uw handen in het aquariumwater komt moeten alle stekkers van de zich in het water bevindende elektrische apparaten uit het stopcontact gehaald worden. Koppel het filter los van het stroomnet alvorens het te openen.



De aansluitkabel van het apparaat kan niet vervangen worden. Bij beschadiging van de kabel mag het apparaat niet meer gebruikt worden. Wendt U zich tot Uw detaillist of een EHEIM-servicedienst.



Dit toestel is niet voorzien voor gebruik door personen (kinderen inbegrepen) met beperkt fysiek, sensorisch of geestelijk vermogen of met gebrekkelijke ervaring of kennis behalve indien een voor de veiligheid bevoegde persoon op hen toezicht houdt of hen instructies heeft gegeven met betrekking tot de bediening van het toestel. Op kinderen moet toezicht worden gehouden om te garanderen dat ze niet met het toestel spelen.



20 cm  Waarschuwing: Bij deze apparaten kunnen magnetische velden elektronische en mechanische storingen of beschadigingen veroorzaken. Dit geldt ook voor pacemakers. De vereiste veiligheidsafstand zijn in de handboeken van deze medische apparaten te vinden.



Let op: Door de grote kracht van de magneten kunnen bij het onderhoud kneuzingen veroorzaakt worden.



Voor Uw eigen veiligheid is het aan te bevelen met het snoer een druppellus te creëren, die verhindert, dat eventueel langs de kabel lopend water in het stopcontact komt. Bij gebruik van een losse contactdoos dient deze boven de filter-aansluitkabel geplaatst te worden.

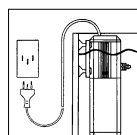

De voorzorgsmaatregelen in acht nemen bij hantering van door elektrostatische ontlading bedreigde componenten.



Het apparaat – of delen daarvan – niet reinigen in de vaatwasmachine. Niet vaatwasmachinebestendig!



Dit product niet in het normale huisvuil gooien. Breng het naar uw lokaal afvalverwerkingspunt.

Dit product is volgens de verschillende nationale voorschriften en richtlijnen erkend en komt overeen met de EU-normen.



Binnenfilter 2048

uitvoering: zie typeplaatje op het pomphuis

Functie

- A** ① Pomp ② filtermodule met patroon ③ uitstroomstuk ④ diffusor ⑤ luchtreguleerventiel ⑥ bevestigingsplaat ⑦ filterbodem ⑧ afsluitschuif ⑨ klemstoppen ⑩ zuignap.

Montage

- B** Klemstoppen in de openingen van de pomp-bevestigingsplaat monteren; zuignappen bevestigen. De bevestigingsplaat kan naar keuze aan alle zijden van de pomp ingeschoven worden, waardoor een filtermontage naar alle richtingen mogelijk is.
- C/D** Naar keuze uitstroomstuk (**C**) of diffusor (**D**) indraaien. Uitstroomstuk: Voor en goed oppervlaktebeweging. Diffusor: Bij voorkeur voor zeewater- en niet beplante zoetwateraquaria. Met het luchtreguleerventiel op de luchtslang van de diffusor kan de zuurstofhoeveelheid gereduceerd worden.

Afsluitschuiven openen, filter in het aquarium bevestigen (zie voor minimale dompdiepte afb. **C**) en via stekker in gebruik nemen.

Ingebruikname

- E** Door het indrukken van de vergrendeling aan de zijkant, kunnen de modules eenvoudig worden afgenomen. Het is, om de biologische filterwerking niet te onderbreken, aan te bevelen de patronen (best. nr. 2615480) om beurten uit te wassen of te vervangen. Dit is nodig als de pompcapaciteit beduidend terugloopt. **PAS OP:** Afsluitschuiven voor het uitnemen van de filter sluiten.
- F** Door het toevoegen of verwijderen van modules kan het filteroppervlak individueel veranderd worden (accessoir: module met filterpatroon, best. nr. 7478860).

Centrifugaal pomp 1048

- A** ① motordeel ② slangpilaar ③ pompdeksel ④ pompdeel

Reiniging en onderhoud

- B/C** Stekker uit stopcontact. Pompdeksel ontgrendelen (**B**) en pompdelen overeenkomstig tekening (**A**) uitnemen. Pomp, zoals afgebeeld onder (**C**) met EHEIM-borstelset (best. nr. 4009550) goed schoonmaken, pompdelen onder stromend water goed reinigen en daarna in dezelfde volgorde terugplaatsen.

LET OP: De pomp mag nooit drooglopen.

Svenska

EHEIM

Säkerhetsanvisningar



Endast för akvariska användningsområden i stängda utrymmen.





Innan du sätter ned handen i vattnet måste du koppla från alla elektriska enheter som befinner sig i vattnet. Koppla från filtret från nätspänningen innan du öppnar det.



Apparatens anslutningskabel kan inte ersättas. Om kabeln skadats får inte filtret användas mer. Ta kontakt med din backbutik eller EHEIMs service-center.

 Denna apparat är inte avsedd att användas av personer (inklusive barn) med begränsad fysisk, sensorisk eller mental förmåga eller som saknar erfarenhet och / eller kunskaper, om inte vederbörande står under uppsikt av en person som ansvarar för säkerheten eller erhåller anvisningar från denna person om hur apparaten ska användas. Barn ska övervakas för att säkerställa att de inte leker med apparaten.

 20 cm  **Observera:** Vid dessa pumpar kan magnetfält framkalla elektroniska eller mekaniska störningar eller skador. Detta gäller även för pacemakers. Erforderliga säkerhetsavstånd anges i handböckerna till de medicinska utrustningarna.

 **Varning!** Risk för klämskador vid underhåll pga. höga magnetiska krafter.

 **Av säkerhetsskäl rekommenderar vi att man hänger anslutningskabeln till filtret så att en droppöglå bildas och förhindrar att eventuellt på kabeln rinnande vatten kommer in i vägguttaget. Om man använder en grenkontakt i vägguttaget bör detta vara högre placerat än kabelanslutningen i filtret.**

 **Beakta försiktighetsåtgärderna vid hantering av elektrostatisch urladdningshotade komponenter.**

 **Rengör inte apparaten – eller delar därav – i diskmaskinen. Ej diskmaskinsäker!**

 **Denna produkt ska inte kastas bort i de normala hushållsoporna. Lämna in den till det lokala återvinningsstället.**

Produkten har godkänts enligt gällande nationella föreskrifter och direktiv och uppfyller tillämpbara EU-direktiv.

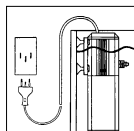

Innerfilter 2048

Version: se typskylten på pumphuset

Funktion

A ① Pump ② Filterbehållare med patron ③ Slanganslutning ④ Diffusor ⑤ Luftkran ⑥ Fästplatta ⑦ Filterbotten ⑧ Avstängnings-spjäll ⑨ Låsclips ⑩ Suganordning.

Montering

B Låsclipsen kläms fast i pumpens fästplatta och suganordningen sättes på. Fästplattan kan även monteras på pumpens sidovägg, vilket gör det möjligt att rikta filtreringen åt alla håll.

C/D Skruva efter önskan på slanganslutning (**C**) eller diffusor (**D**). Utström-mare: Ger bra ytvattenrörelse. Diffusor: Denna är lämplig för saltvatten-akvarier och sötvattenakvarier utan växter. Tillförseln av syre kan regleras med luftkranen.

Öppna spjällen för vatteninsug. Häng upp filtret i akvariet (minimidjup se bild **C**) och sätt i stickkontakten.

Igångsättning

E Genom att trycka på sidospärrarna kan modulerna lätt avlägnas. För att inte avbryta den biologiska filtreringsprocessen bör filterpatronerna växelvis rengöras alternativt bytas ut (beställningsnr: 2615480). Detta är nödvändigt, när pumpeffekten märkbart minskar. **OBSERVERA:** Avstängningsspjällen skall stängas, innan filtret lyfts bort.

F Genom att minska eller öka antalet moduler kan filtreringsytan ändras individuellt. (Tillbehör: Behållardel med filterpatron nr: 7478860).

Cirkulationspump 1048

A ① Motordel ② Slanganslutning tryck ③ Pumplock ④ Pumpdelar

Skötsel och underhåll

B/C Dra ut stickkontakten. Avlägsna pumplocket (**B**) och tag ut pumpdelarna enl skiss **A**. Rengör pumpen som visas på bild (**C**) med EHEIM:s rengöringsborst-set (nr: 4009550). Rengör pumpdelarna under rinnande vatten och sätt därefter ihop dem i samma ordningsföljd.

OBSERVERA: Pumpen får inte arbeta utan vatten.

Norsk

EHEIM

Säkerhetsanvisningar



Kun for innerdørs bruk. For akvariebruk.



Før man stikker hånden ned i akvarievannet, må kan koble alle elektriske apparater i vannet fra strømmettet. Før man åpner filteret, skal dette kobles helt fra strømmettet.



Strømkabelen til dette apparatet kan ikke skiftes. Dersom ledningen har blitt skadet må apparatet ikke lengre brukes. Kontakt din spesialforhandler eller ditt EHEIM service senter.



Dette apparatet er ikke egnet for bruk av personer (inklusive barn) med nedsatte fysiske, sensoriske eller mentale evner eller med manglende erfaring og/eller manglende kunnskaper, med mindre disse personene er under oppsikt av en annen person som er ansvarlig for deres sikkerhet eller har fått anvisninger fra en slik person om hvordan apparatet skal brukes. Barn skal holdes under oppsikt for å unngå at de leker med apparatet.



20 cm



Merk: Ved disse apparatene kan magnetfelt forårsake elektroniske og mekaniske forstyrrelser eller skader. Dette gjelder også for pacemakers. De nødvendige sikkerhetsavstandene står oppført i håndbøkene som tilhører disse medisinske apparatene.



OBS! Ved vedlikeholdsarbeider er det fare for å skade seg pga. sterke magnetkrefter.



For din egen sikkerhet anbefaler vi at du lar ledningen danne en „drypp-løkke“ som sikrer at vann ikke renner langs ledningen inn i veggkontakten. Dersom skøteledninger med flere uttak brukes, må disse plasseres høyere enn stikkkontakten for filteret.

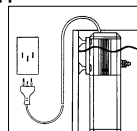

Ta hensyn til vernetiltak ved behandling av byggeelementer som kan være utsatt for elektrostatisk utladning.



Apparatet – inkludert dets enkeltdeleer – må ikke vaskes i oppvaskmaskin. Utstyret tåler ikke maskinvask!



Produktet må ikke kastes som vanlig husholdningsavfall. Det skal leveres til ditt lokale deponi.

Produktet er prøvet ifølge de respektive nasjonale forskrifter og er i samsvar med EU-normene.



Innvendig filter 2048

Utførelse: Se typeskiltet på pumpehuset

Funksjon

- A ① Pumpe ② Filterbeholder med patroner ③ Utstrømmerstuss ④ Diffusor ⑤ Luftventil ⑥ Festeplate ⑦ Filterbunn ⑧ Skyvelukkerne ⑨ Klemmepropp ⑩ Sugeskive.

Montering

- B Klemmeproppen settes i åpningene på pumpens festeplate. Sett på gum-miknottene. Festeplaten kan også skyves inn på pumpens sidevegger slik at filteret kan monteres med forskjellige utstrømmerretninger.
- C/D Skru fast enten utstrømmerstusser (C) eller diffusor (D).
Utstrømmerstusser: For god bevegelse i vannoverflaten.
Spreader: Denne anbefales både til saltvanns- og ferskvannsakvarier uten planter. Lufttilførselen reguleres ved hjelp av luftventilen.
Skyvelukkerne åpnes og filteret festes i akvariet. (Minimums dybde for feste, se bilde C). Så settes støpselet i.

Igangsettelse

- E Ved å trykke inn sideklemmene kan modulene lett taes av. For at den biologiske filterprosessen ikke skal avbrytes, bør ikke rengjøring eller utskifting av alle patroner (bestill. nr. 2615480) skje samtidig. Dette bør foregå når pumpeytelsen har avtatt merkbart. **OBS:** Før filteret taes ut må skyvelukkerne stenges.
- F Ved å ta vekk eller øke antallet moduler kan filterflaten tilpasses individuelt. (Tilbehør: Beholderdel med filterpatroner, bestill. nr. 7478860).

Sirkulasjonspumpe 1048

- A ① Motorkropp ② Skrustuss ③ Festing ④ Pumpedeler

Stell og vedlikehold

- B/C Kontakten trekkes ut, festeringen skrues av (B) og pumpedelene taes av i den rekkefølge tegningen (A) viser. Rengjør så pumpen (C) kraftig med EHEIM-rengjøringsbørstesett (nr. 4009550). Rengjør pumpedelene under rennende vann, og sett dem sammen igjen i riktig rekkefølge.
VIKTIG: Pumpen må aldri stanses uten å være nedsenket i vann.

Suomi

EHEIM

Turvallisuusmääräykset



Laitte on tarkoitettu ainoastaan sisätilakäyttöön ja akvaarioissa käytettäväksi.



Ennen kuin panet käden veteen, varmista että kaikki vedessä olevat sähkölaitteet on kytketty irti verkkovirrasta. Irrota laite aina verkkovirrasta, ennen kuin avaat suodattimen.



Sähköjohtoa ei voi vaihtaa uuteen. Jos sähköjohto on vaurioitunut, sitä ei saa enää käyttää. Ota silloin yhteys EHEIM kauppiaseesi.



Tätä laitetta ei ole tarkoitettu sellaisten henkilöiden (mukaanlukien lapset) käyttöön, joiden fyysiset, sensoriset tai henkiset kyvyt ovat puutteelliset johtuen kokemuksen ja/tai tiedon puutteesta, ellei turvallisuudesta vastuussa oleva henkilö valvo käyttöä tai ole antanut ohjeita miten laitetta

käytetään asianmukaisesti. Valvo lasten käyttäytymistä ja varmista, että he eivät leiki laitteella.



20 cm



Viite: Magneettikentät voivat aiheuttaa näissä laitteissa elektrosydämen tahdistinta. Tarpeelliset turvallisuuse täisyydet voidaan löytää näiden lääke tieteel listen laitteiden käsikirjoista.



Huomio: huoltotoissa ruhjontavaara suurten magneettivoimien johdosta.



Oman turvallisuutesi vuoksi varmista että suodattimen sähköjohtoa ei vedetä suoraan pistorasiaan vaan asetetaan piirroskuvan mukaisesti mutkalle. Tämä estää vesipisaroiden pääsyn pistorasiaan. Mikäli käytät jakorasiaa niin aseta se suodattimen yläpuolelle; ei lattialle.



Huomioi varotoimenpiteet sähköstaattisesti purkausturvallisten rakenneosien käsittelyssä.



Älä puhdista laitetta – tai sen osia – astianpesukoneessa. Ei kestä pesua astianpesukoneessa!



Tätä tuotetta ei saa hävittää talousjätteiden joukossa. Toimita tuote paikalliseen jätehuoltopisteeseen.

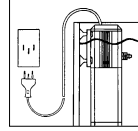

Tuote on hyväksytty kunkin maan kansallisten määräysten ja ohjesääntöjen mukaan ja se vastaa EU-standardien määräyksiä.



Sisäsuodatin 2048

Valmistustapa: katso nimilaattaa pumpun suojuksessa

Toiminta

- A** ① pumppuyksikkö ② suodatinsäiliö ja patruuna ③ poistosuutin ④ hapetin ⑤ Ilmansäätoventtiili ⑥ kiinnityslista ⑦ suodatinsäiliön pohja ⑧ suodatinsäiliön ⑨ pidiketapit ⑩ imukupit.

Asennus

- B** Paina pidiketapit kiinnityslevyssä oleviin aukkoihin. Kiinnitä imukupit pidiketappeihin. Kiinnityslistoja pumppuyksikön eri kulmiin asentamalla voidaan poistoaukko laittaa suihkuttamaan kulloinkin haluttuun suuntaan.

- C/D** Valinnaisesti asennetaan olostuloaukkoon joko hapetin tai poistosuutin. Poistosuuttimella aikaansaadaan voimakkaa pintavedenkierto. Hapetin: Suositellaan käytettäväksi kasvittomissa meri- ja makeanvedenakvaarioissa.

Aukaise suodatinsäiliöiden umuaukot, kiinnitä suodatin akvaarion (vähimmäisupotussyvyys kts kuva **C**), ja laita laite toimimaan työntämällä pistoke pistokerasiaan.

Käyttöönotto

- E** Painamalla kevyesti suodatinsäiliön sivuissa olevia kiinnityskohtia voidaan suodatinsäiliöt irroittaa toisistaan. Jotta biologinen suodatusprosessi jatkuisi keskeytyksettä, suositellaan patruunoiden (til.no. 2615480) pesue tai vaihtoa vuorotollen. Toimenpiteet ovat tarpeellisia, kun suodattimen pumppausteho näyttää pienentyneen. **HUOM!** Sulje suodatinsäiliöiden imuaukot ennen akvaariosta nostamista!
- F** Poistamalla tai lisäämällä suodatusmoduleita voidaan suodatuspinta-alaa muuttaa yksiköiden tarpeiden mukaiseksi (suodatusmoduli 7478860).

Keskipakopumppu 1048

A ① moottori ② kierrelliitin ③ lukkorengas ④ roottori

Hoito ja huolto

B/C Vedä pistoke pistorsiasta. Irroita lukkorengas ja roottori perusteellista puhdistusta varten (**C**). Puhdistushajoilla (til.no. 4009550) harjataan voimakkaasti pumppupesä ja roottori puhdistetaan juoksevan veden alla. Tämän jälkeen osat asetetaan oikeille paikoilleen.

VAROITUS! Pumppua ei koskaan saa käyttää kuivana.

Dansk

EHEIM

Sikkerhedsanvisninger



Kun til brug indendørs. Til akvariebrug.



Før man stikker hånden ned i akvarievandet, skal alle akvariets elektriske installationer fjernes fra lysnettet. Før filteret åbnes, skal strømmen til det altid afbrydes.



Apparatets elektriske ledning kan ikke udskiftes. Efter beskadigelse af ledningen må apparatet ikke mere benyttes. Henvend dig til din faghandler eller på et EHEIM-serviceværksted.



Apparatet er ikke beregnet til at blive anvendt af personer (herunder også børn) med indskrænkede fysiske, sensoriske eller åndelige evner eller som ikke råder over den tilsvarende erfaring og/eller viden, hvis ikke der føres tilsyn af en person, som er ansvarlig for sikkerheden og som giver de tilsvarende instruktioner om, hvordan apparatet skal benyttes. Der skal føres tilsyn med børn for at sikre, at de ikke leger med apparatet.



20 cm



Bemærk! Disse pumper frembringer magnetfilter, der kan forårsage elektroniske og mekaniske fejl eller skader. Dette gælder også for pacemakere. De nødvendige sikkerhedsafstande fremgår af dokumentationen til disse medicinske apparater.



Advarsel: Ved vedligeholdelsesarbejde er der fare for klemning på grund af de magnetiske kræfter.



For din egen sikkerhed betaler det sig at lade ledningen danne en drypsløjfe, som hindrer vandet i at løbe langs ledningen ned til kontakt eller stikdåse. Ved anvendelse af en folderstikdåse skal denne placeres højere end filtrets nettilslutning.

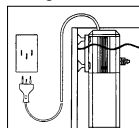

Overhold sikkerhedsforholdsreglerne ved håndtering af komponenter med fare for afladning af elektrostatisk energi.



Apparatet – inkludert dets enkeltdele – må ikke vaskes i oppvaskmaskin. Utstyret tåler ikke maskinvask!



Dette produkt må ikke bortskaffes sammen med det normale husholdningsaffald. Afløvér produktet hos det lokale genbrugscenter.

Produktet er godkendt efter gældende nationale forskrifter og direktiver og opfylder EU-normene.



Indvendig filter 2048

Version: se typskylden på pumphuset

Funktion

- A** ① Pumpe ② Filterbeholder med patron ③ Udløbsstuds ④ Diffusor ⑤ Luftventil ⑥ Beslag ⑦ Filterbund ⑧ Skydelås ⑨ Klemholder ⑩ Sugekopper.

Montering

- B** Klemholderne klipses fast i beslagets huller. Sugekopperne sættes på. Beslaget kan også fastgøres på siden af pumpen, hvorved det er muligt at montere filteret i hvilken som helst retning.
- C/D** Enten udløbsstuds (**C**) eller diffusor (**D**) skrues på.
Udløbsstuds: til god overfladebevægelse. Spreader: Denne anbefales til både salt- og ferskvandsakvarier uden planter. Iltforsyningen reguleres ved hjælp af luftventilen.
- Skydelåsen åbnes, filteret fastgøres i beslaget og tændes ved kontakten. (Se billede **C** for placering af pumpen under vandet).

Ibrugtagning

- E** Modulerne kan let skilles ad ved at trykke på klipsene på siden af pumpen. For ikke at afbryde den biologiske filtreringsproces anbefales det enten at vaske eller at udskifte patronerne en ad gangen. (Bestillingsnr. 2615480). Dette er nødvendigt, hvis pumpens ydelse går mærkbart ned. **VIGTIGT:** Skydelåsen skal lukkes, før filteret tages ud.
- F** Ved at reducere eller tilføje yderligere moduler kan filtreringsoverfladen ændres individuelt. (Tilbehør: beholderdel med filterpatron, bestillingsnr. 7478860).

Cirkulationspumpe 1048

- A** ① Motorhus ② Gevindstuds ③ Klemring ④ Pumpedele

Pleje og vedligeholdelse

- B/C** Træk kablet ud af stikket. Klemringen skrues af (**B**) og pumpedelene tages ud som vist på billede (**A**). Pumpen rengøres grundigt som vist på billede (**C**) med EHEIM rengørings sæt (bestillingsnr. 4009550). Pumpedelene rengøres under rindende vand og sættes til sidst sammen igen i modsat rækkefølge.

VIGTIGT: Pumpen må ikke køre uden vand.

Italiano

EHEIM

Avvertenze di sicurezza



Da utilizzarsi soltanto all'interno di ambienti. Uso per acquari.





Durante gli interventi di cura e manutenzione, si devono disinserire dalla rete tutti gli apparecchi elettrici immersi in acqua. Prima di procedere all'apertura del filtro, scollegarlo sempre dalla rete elettrica.





Il cavo di collegamento dell'apparecchio non può essere sostituito. Non usare più l'apparecchio in presenza di un cavo danneggiato. Rivolgersi al rivenditore di fiducia o a un punto di assistenza EHEIM.

Il presente apparecchio non è progettato per essere utilizzato da persone

 (bambini compresi) con ridotte capacità fisiche, sensoriali o psichiche o che non siano dotate della necessaria esperienza/conoscenza, a meno che non siano assistite e controllate da una persona addetta alla sicurezza o ricevano dalla stessa le istruzioni relative all'utilizzo dell'apparecchio. Tenere sempre sotto controllo i bambini, per assicurarsi che non giochino con l'apparecchio.

  20 cm **Avvertenza:** in questi apparecchi, i campi magnetici possono causare malfunzionamenti o avarie elettroniche e meccaniche. Questo vale anche per i pacemaker. Le distanze di sicurezza da rispettare sono indicate nei manuali d'uso di tali apparecchiature medicali.

 **Attenzione:** durante gli interventi di manutenzione sussiste il rischio di schiacciamento originato da forze magnetiche elevate.

 Per ragioni di sicurezza si consiglia di formare con il cavo elettrico un giro per far gocciolare l'acqua con lo scopo di impedire che viene acqua che scorra lungo il cavo possa entrare nella presa. Se si usa una presa distributrice, la sistemazione deve avvenire al di sopra del collegamento alla rete del filtro.

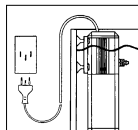

 **Rispettare** le misure di sicurezza per l'utilizzo di componenti a rischio di scariche elettrostatiche.

 **Non lavare** il dispositivo – o componenti dello stesso – in lavastoviglie. Non resiste al lavaggio in lavastoviglie.

 **Non smaltire** il prodotto assieme ai comuni rifiuti domestici. Consegnare il prodotto alla discarica locale autorizzata.

Il prodotto è omologato secondo le vigenti disposizioni e direttive nazionali ed è conforme alle norme EU.



Filtro interno 2048

Versione: vedere targhetta di identificazione sul corpo della pompa

Funzionamento

A ① pompa ② recipiente con cartuccia filtrante ad azione biologica ③ bocchettone di mandata ④ insufflatore ⑤ valvola di regolazione dell'aria ⑥ piastra di fissaggio ⑦ base filtro ⑧ saracinesca di chiusura ⑨ clip di fissaggio ⑩ ventose.

Installazione

B Spingere le clips nelle aperture della piastra di fissaggio della pompa; applicare le ventose. E' possibile inserire la piastra di fissaggio, a scelta, anche sulla fiancata della pompa; con essa è possibile un montaggio del filtro in tutte le posizioni.

C/D Avvitare, a scelta, il bocchettone di mandata (**C**) oppure l'insufflatore (**D**). Bocchettone di mandata: per un buon funzionamento dell'acqua in superficie. Diffusore: è preferibile usarlo in acquari marini o d'acqua dolce senza piante. L'apporto di ossigeno può essere regolato con la valvola di regolazione dell'aria.

Aprire la saracinesca di chiusura, fissare il filtro nell'acquario (minima profondità dell'immersione vedi fig. **C**), collegarlo alla rete elettrica.

Messa in esercizio

E Mediante la presa sui punti laterali di bloccaggio si possono togliere

facilmente i moduli. Per non interrompere il processo del filtraggio biologico, si raccomanda di sciacquare o sostituire alternativamente le cartucce filtranti (n. 2615480). Questa operazione si rende necessaria, quando la resa della pompa di minuisce in modo apprezzabile. **AVVERTENZA:** prima di estrarre il filtro, chiudere la saracinesca di chiusura.

- F E' possibile diminuire o ampliare la superficie filtrante togliendo o aggiungendo semplicemente dei moduli (accessorio: recipiente con cartuccia filtrante n. 7478860).

Pompa centrifuga Universal 1048

- A ① blocco motore ② raccordo filettato ③ ghiera di fissaggio ④ parti della girante

Manutenzione

- B/C** Disinserire la spina dalla rete elettrica. Sbloccare la ghiera di fissaggio (**B**) e togliere le parti della pompa come da disegno (**A**). Pulire accuratamente la pompa, come illustrato nel disegno (**C**), con il set di scovoli EHEIM (n. 4009550). Sciacquare le parti della pompa sotto acqua corrente e, successivamente reinserirli nella loro sede nello stesso ordine.

AVVERTENZA: la pompa non deve funzionare a secco.

Español

EHEIM

Avvertenze di sicurezza



Utilizar exclusivamente en espacios cerrados. Para aplicaciones en acuariofilia.



Antes de introducir la mano en el agua del acuario, desenchufar todos los aparatos eléctricos que se encuentren en el agua.



No se puede cambiar el cable de conexión del aparato. Si se estropeara el cable, no podrá utilizarse más el aparato. En tal caso, diríjase a su comercio especializado o al servicio de atención al cliente de EHEIM.



Este aparato no está pensado para las personas (incluidos los niños) que tengan mermadas sus capacidades físicas, sensoriales o mentales ni debe ser utilizado por personas que carezcan de la experiencia y/o los conocimientos necesarios, a no ser que estas personas sean supervisadas por un responsable de seguridad o recibieron las instrucciones necesarias para utilizar el aparato. Vigile a los niños para evitar que jueguen con este aparato.



20 cm  Nota: En estos aparatos, los campos magnéticos pueden causar fallos o daños electrónicos y mecánicos. Lo antedicho también rige para marcapasos. Las distancias necesarias de seguridad deben consultarse en los manuales de dichos aparatos médicos.



Atención: Peligro de aplastamiento en trabajos de mantenimiento por altas fuerzas magnéticas.



Por su propia seguridad se recomienda dejar que cuelgue el cable para evitar que pueda gotear el agua a lo largo del mismo hasta llegar a la caja de enchufe. Si se emplea una caja de distribución, ésta deberá estar situada por encima de la toma de corriente del filtro.

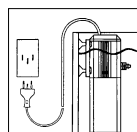

Tener en cuenta las medidas de precaución al manipular elementos constructivos susceptibles de descarga electrostática.



No limpiar el aparato ni sus componentes en un lavavajillas. ¡No es resistente al lavavajillas!



No tire este producto a la basura doméstica normal. Llévelo a su punto local de eliminación de residuos.

El producto está aprobado según las prescripciones y directrices nacionales de cada país y cumple las normas de la EU.



Filtro interior 2048

Acabado: véase placa de características en la carcasa de la bomba

Funcionamiento

- A** ① Bomba ② Recipiente filtrante con cartucho ③ Prolongador de tubo de salida ④ Difusor ⑤ Regulador ⑥ Placa fijación ⑦ Suelo filtro ⑧ Pasador de cierre ⑨ Tapón apriete ⑩ Ventosa.

Montaje

- B** Encajar tapón apriete en las aberturas de la placa de fijación de la bomba, colocar la ventosa. La placa de fijación se puede introducir también, a elección, en las paredes laterales de la bomba, por lo que es posible el montaje del filtro en todas las direcciones.

- C/D** Atornillar alternativamente el prolongador del tubo de salida (**C**) o el difusor (**D**). Prolongador del tubo de salida para un buen movimiento de superficie. Difusor, con preferencia para acuarios de agua de mar y agua dulce sin plantas; con la reguladora en la manga de aire del difusor se puede disminuir la cantidad de oxígeno.

Abrir el pasador de cierre. Colocar el filtro en el acuario (profundidad mínima de inmersión, véase dibujo **C**), y conectar a través de un enchufe con la red.

Puesta en servicio

- E** Apretando los puntos laterales de fijación, es fácil retirar los módulos. Para no interrumpir el proceso biológico de filtración se recomienda el lavado o la sustitución alternativa de los cartuchos (nº pedido: 2615480). Esto es necesario cuando el rendimiento de la bomba va bajando considerablemente. **Atención:** Antes de sacar el filtro, cerrar el pasador de cierre.
- F** Al reducir o ampliar los módulos se puede cambiar individualmente la superficie de filtración. (Accesorio: Pieza recipiente con cartucho de filtro, nº pedido: 7478860).

Bomba centrífuga 1048

- A** ① Cuerpo motor ② Racor ③ Anillo soporte ④ Piezas bomba

Cuidados y mantenimiento

- B/C** Tirar del enchufe de la red. Descerrear el anillo soporte (**B**) y sacar las piezas de bomba según dibujo (**C**), limpiar a fondo con el juego de cepillos de limpieza de EHEIM (nº pedido: 4009550). Limpiar las piezas de la bomba debajo del grifo y a continuación volveras a juntar en el mismo orden. **Atención: La bomba no debe funcionar en seco.**

Vervielfältigungen oder Kopien – auch auszugsweise –
nur mit ausdrücklicher Genehmigung des Herstellers.

Reproduction or copying – even parts thereof –
only with the express permission of the producer.

Les reproductions, copies et utilisations de nos logos et
matériels et produits dérivés sont interdits à l'exploitation,
de toute nature, et sont soumises au préalable, par écrit,
au consentement et à l'approbation du fabricant.



EHEIM GmbH & Co. KG
Plochinger Str. 54
73779 Deizisau
Germany
Tel. +49 7153/70 02-01
Fax +49 7153/70 02-174



**Müller + Pflieger
GmbH & Co. KG**
Industriegebiet
Kreuzwiese 13
67806 Rockenhausen
Germany
Tel. +49 6361/9 21 60
Fax +49 6361/76 44



Eugen Jäger GmbH
Auf dem Berg 31
71543 Wüstenrot
Germany
Tel. +49 7945/633
Fax +49 7945/13 61

www.eheim.de